

FEATURES

- **Low profile:**
22.5 mm(L)×15 mm(W)×15.7 mm(H)
.886 inch(L)×.591 inch(W)×.618 inch(H)
- **Low temperature rise**
Terminal temperature has been reduced compared with using our conventional product
- **Low sound pressure level**
Noise level has been reduced approx.10dB compared with using our conventional product.
- **Wide line-up**
Micro ISO/Micro 280 terminal types and resistor and diode inside type, PCB terminal type (Micro 280 only).
- **Plastic sealed type**
Plastically sealed for automatic cleaning.

- **Compact and high-capacity 20A load switching**
N.O.: 20A 14V DC, N.C.: 10A 14V DC
(Max. carrying current: at 85°C 185°F)

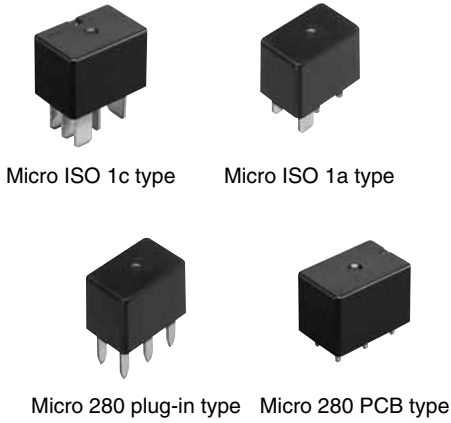

TYPICAL APPLICATIONS

- Headlights
- Magnetic clutches
- Radiator fans
- Blowers
- Fog lamps
- Tail lights
- Heaters
- Defoggers
- Horns
- Condenser fans, etc.

SPECIFICATIONS

Contact		1 Form A	1 Form C
Arrangement		1 Form A	1 Form C
Contact material		Silver alloy	
Initial contact resistance (By voltage drop 6 V DC 1 A)		Max. 50mΩ	
Contact voltage drop		Max. N.O.: 0.2 V (at 20 A)	Max. N.O.: 0.2 V (at 20 A switching) Max. N.C.: 0.5 V (at 10 A switching)
Rating	Nominal switching capacity	N.O.: 20 A 14 V DC	N.O.: 20 A 14 V DC N.C.: 10 A 14 V DC
	Max. carrying current	N.O.: 20 A (Continuous, at 85°C 185°F) 50 A for 2 minutes, 40 A for 1 hour (at 20°C 68°F) 40 A for 2 minutes, 30 A for 1 hour (at 85°C 185°F)	<N.O.> N.O.: 20 A (Continuous, at 85°C 185°F) 50 A for 2 minutes, 40 A for 1 hour (at 20°C 68°F) <N.C.> N.C.: 10 A (Continuous, at 85°C 185°F) 40 A for 2 minutes, 30 A for 1 hour (at 85°C 185°F)
	Min. switching capacity#1	1 A 12 V DC	
Expected life (min. operation)	Mechanical (at 120 cpm)	Min. 10 ⁶	
	Electrical (at rated load)	Min. 10 ⁵ *1	

Coil	
Nominal operating power	0.8 W, 1.0 W (with resistor inside type)

#1 This value can change due to the switching frequency, environmental conditions, and desired reliability level, therefore it is recommended to check this with the actual load.

Characteristics		
Max. operating speed (at nominal switching capacity)	15cpm	
Initial insulation resistance*2	Min. 20MΩ (at 500 V DC)	
Initial breakdown voltage*3	Between open contacts	500 Vrms for 1min.
	Between contacts and coil	500 Vrms for 1min.
Operate time*4 (at nominal voltage) (at 20°C 68°F) (initial)	Max. 10ms	
Release time*4 (at nominal voltage) (at 20°C 68°F) (initial)	Max. 10ms Max. 15ms (with diode inside type)	
Shock resistance	Functional*5	Min. 100 m/s ² {10 G}
	Destructive*6	Min. 1,000 m/s ² {100 G}
Vibration resistance	Functional*7	10 Hz to 100 Hz, Min.44.1 m/s ² {4.5 G}
	Destructive*8	10 Hz to 500 Hz, Min.44.1 m/s ² {4.5 G}
Conditions in case of operation, transport and storage*9 (Not freezing and condensing at low temperature)	Ambient temp*10	-40°C to +85°C -40°F to +185°F
	Humidity	25% R.H. to 85% R.H.
Mass	Approx. 15.0g .53 oz	

Remarks

- *1 At nominal switching capacity, operating frequency: 2s ON, 2s OFF
- *2 Measurement at same location as "Initial breakdown voltage" section.
- *3 Detection current: 10mA
- *4 Excluding contact bounce time.
- *5 Half-wave pulse of sine wave: 11 ms; detection time: 10 μs
- *6 Half-wave pulse of sine wave: 6 ms
- *7 Detection time: 10 μs
- *8 Time of vibration for each direction;
X, Y, Z direction: 4 hours



- *9 Refer to 6. Conditions for operation, transport and storage mentioned in AMBIENT ENVIRONMENT
- *10 Ambient temperature 125°C 257°F type is also considerable on request. Please contact us for details.

ORDERING INFORMATION

Ex.

A	CV	1	2	0	12
---	----	---	---	---	----

Product name	Contact arrangement	Mounting classification	Type classification	Coil voltage, V DC
CV	1: 1 Form C 3: 1 Form A	1: Micro ISO plug-in type 2: Micro 280 plug-in type 3: Micro 280 PC board type	0: Standard type 1: With diode inside 2: With resistor inside	12: 12

Note: Standard packing; Carton (Tube): 50 pcs.; Case: 200 pcs.

TYPES

1. Micro ISO terminal type

Coil voltage (DC)	Contact arrangement	Mounting classification	Type classification	Part No.
12 V	1 Form A	Plug-in terminal	Standard type	ACV31012
			With diode inside type	ACV31112
			With resistor inside type	ACV31212
	1 Form C		Standard type	ACV11012
			With diode inside type	ACV11112
			With resistor inside type	ACV11212

2. Micro 280 terminal type

Coil voltage (DC)	Contact arrangement	Mounting classification	Type classification	Part No.
12 V	1 Form A	Plug-in terminal	Standard type	ACV32012
			With diode inside type	ACV32112
			With resistor inside type	ACV32212
		PC board terminal	Standard type	ACV33012
			With diode inside type	ACV33112
			With resistor inside type	ACV33212
	1 Form C	Plug-in terminal	Standard type	ACV12012
			With diode inside type	ACV12112
			With resistor inside type	ACV12212
		PC board terminal	Standard type	ACV13012
			With diode inside type	ACV13112
			With resistor inside type	ACV13212

COIL DATA (at 20°C 68°F)

Nominal voltage, V DC	Pick-up voltage, * V DC (Initial)	Drop-out voltage, V DC (Initial)	Coil resistance, W	Nominal operating current, mA	Nominal operating power, W	Usable voltage range, V DC
12	Max. 7.0	Min. 0.6	180±10% 142.3±10% (with resistor)	67±10% 84±10% (with resistor)	0.8 1.0 (with resistor)	10 to 16

* Other pick-up voltage types are also available. Please contact us for details.

DIMENSIONS

mm inch

1. Micro ISO terminal type

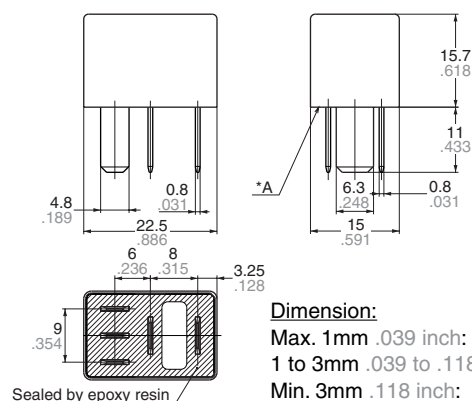
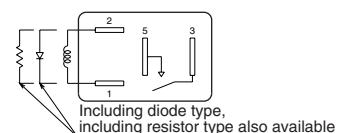
Schematic (Bottom view)
1 Form A

1 Form C

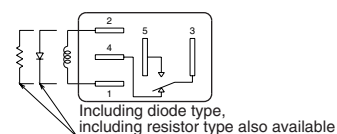

* Intervals between terminals is measured at A surface level.

CV (ACV)

2. Micro 280 terminal type

mm inch

1). Plug-in type

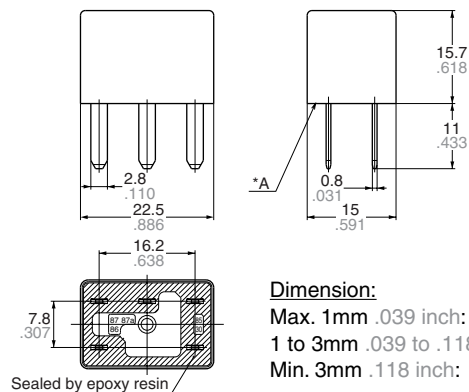

Dimension:
 Max. 1mm .039 inch: $\pm 0.1 \pm .004$
 1 to 3mm .039 to .118 inch: $\pm 0.2 \pm .008$
 Min. 3mm .118 inch: $\pm 0.3 \pm .012$

Tolerance
 $\pm 0.1 \pm .004$
 $\pm 0.2 \pm .008$
 $\pm 0.3 \pm .012$

Schematic (Bottom view)
1 Form A

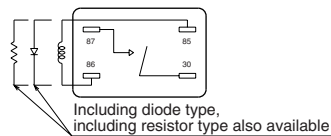

1 Form C

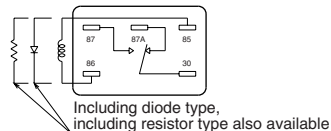

* Intervals between terminals is measured at A surface level.

2). PC board type

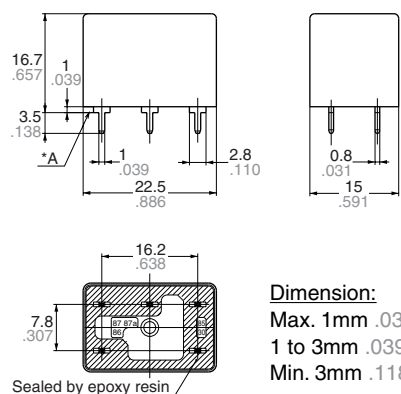

Dimension:
 Max. 1mm .039 inch: $\pm 0.1 \pm .004$
 1 to 3mm .039 to .118 inch: $\pm 0.2 \pm .008$
 Min. 3mm .118 inch: $\pm 0.3 \pm .012$

Tolerance
 $\pm 0.1 \pm .004$
 $\pm 0.2 \pm .008$
 $\pm 0.3 \pm .012$

Schematic (Bottom view)
1 Form A

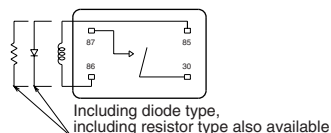

1 Form C

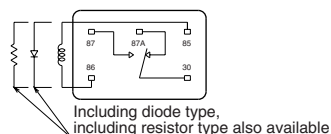

* Dimensions (thickness and width) of terminal specified in this catalog is measured before pre-soldering. Intervals between terminals is measured at A surface level.

REFERENCE DATA

1. Coil temperature rise (20A)

Point measured: Inside the coil
 Contact carrying current: 20A
 Coil applied voltage: 13.5V

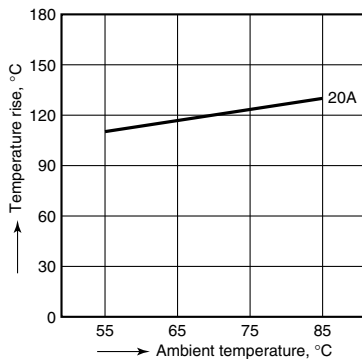

2. Distribution of pick-up and drop-out voltage

Sample: ACV11012, 100pcs

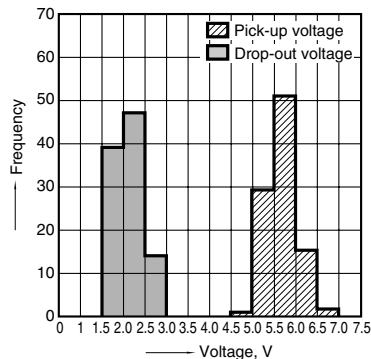

3. Distribution of operate and release time

Sample: ACV11012, 100pcs.

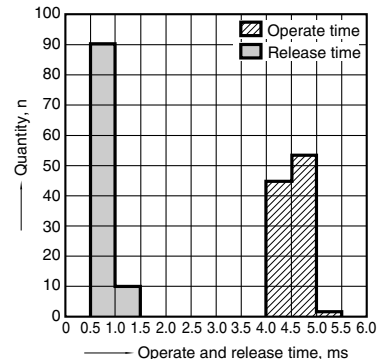

4-(1). Electrical life test (Resistive load)

Sample: ACV12212, 3pcs.
 Load: Resistive load (NC switching) 11A
 Switching frequency: (ON : OFF = 1s : 1s)
 Ambient temperature: Room temperature

Circuit

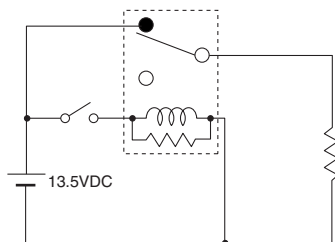

Change of pick-up and drop-out voltage

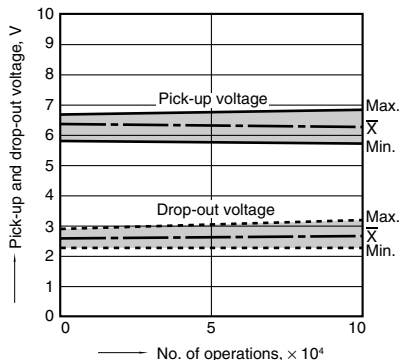

Change of contact resistance

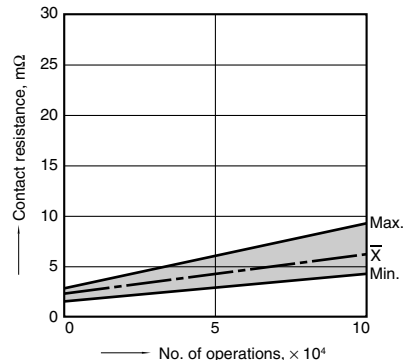

Load current waveform

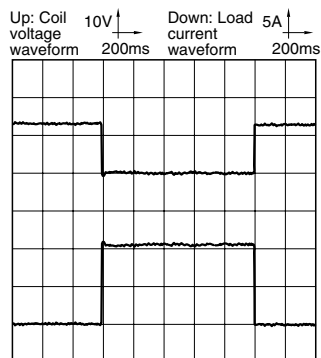

4-(2). Electrical life test (Lamp load)

Sample: ACV12212, 3pcs.
 Load: 55Wx4, inrush: 90A/steady: 20A,
 lamp actual load
 Switching frequency: (ON : OFF = 1s : 14s)
 Ambient temperature: Room temperature

Circuit

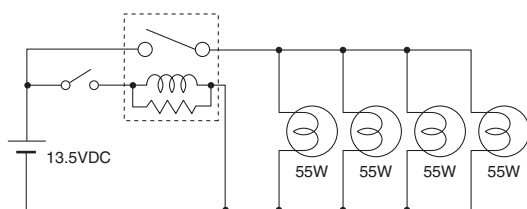

Change of pick-up and drop-out voltage

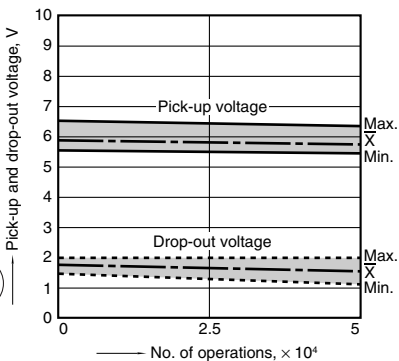

Change of contact resistance

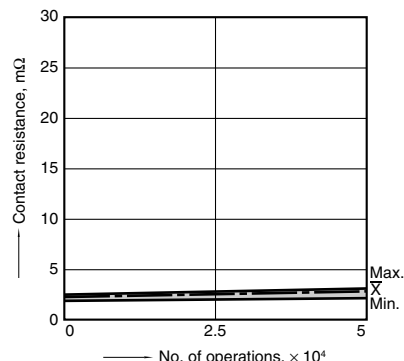

Load current waveform

Inrush current: 90A, steady current: 20A

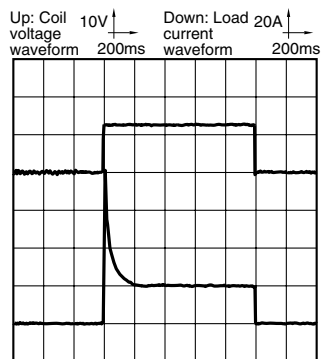

CV (ACV)

4-(3). Electrical life test (Motor load)

Sample: ACV12212, 3pcs.
 Load: inrush: 80A/steady: 18A,
 radiator fan actual load (motor free)
 Switching frequency: (ON : OFF = 2s : 6s)
 Ambient temperature: Room temperature

Circuit

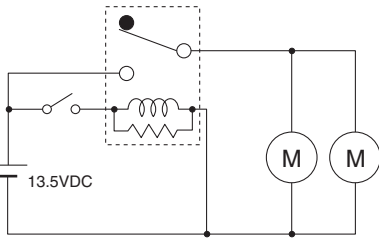

Load current waveform

Inrush current: 80A, steady current: 18A

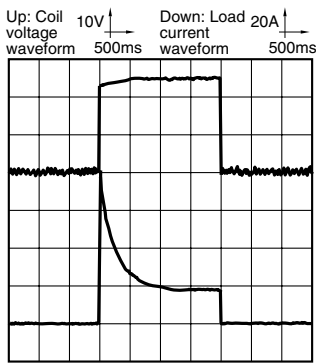

Change of pick-up and drop-out voltage

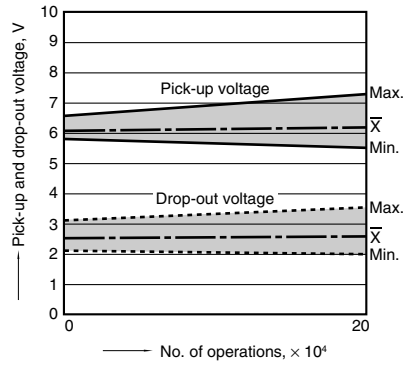

Change of contact resistance

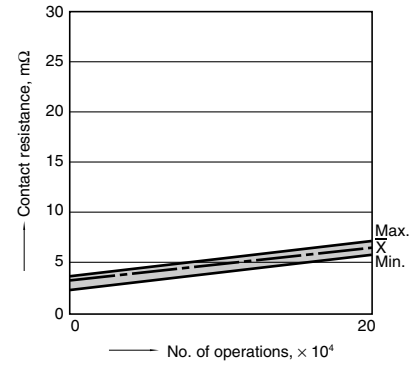

Cautions regarding the protection element

1. Part numbers without protection elements

• 12 V models

When connecting a coil surge protection circuit to these relays, we recommend a Zener diode with a Zener voltage of 24 V or higher, or a resistor (680Ω to 1,000Ω). When a diode is connected to the coil in parallel, the release time will slow down and working life may shorten. Before use, please check the circuit and verify that the diode is not connected in parallel to the coil drive circuit.

2. Part numbers with diodes

These relays use a diode in the coil surge protection element. Therefore, the release time is slower and the working life might be shorter compared to part numbers without protection elements and part numbers with resistors.

Be sure to use only after evaluating under actual load conditions.

3. Part numbers with resistors

This part number employs a resistor in the coil surge protection circuit; therefore, an external surge protection element is not required. In particular, when a diode is connected in parallel with a coil, the revert time becomes slower which could adversely affect working life. Please check the circuit and make sure that a diode is not connected in parallel with the coil drive circuit.

For Cautions for Use, see Relay Technical Information